

Genetics for the Primary Care Provider

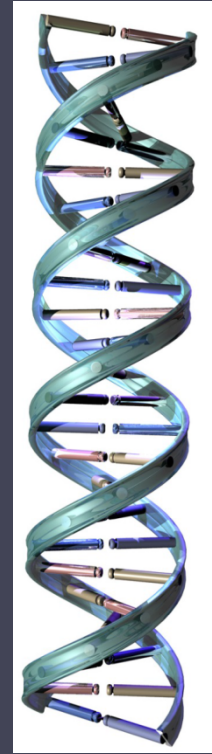

Precision Medicine Update

Nguyen H. Park, MS, PA-C, DFAAPA
President & Founder
Society of Physician Assistants in Genetics &
Genomics



Disclosures

Unfortunately, Ms. Park has no relevant financial relationships with commercial interests to report.



Special thanks to lecturers at the recent NIH/NHGRI Short Course for PAs who allowed me to rummage through their exceedingly brilliant brains and provided some slides for this lecture including Bob Wildin, MD, Jean Jenkins, PhD, RN Aniwaa Owusu-obeng, PharmD, and Wendy Rubenstein, MD, PhD.



NIH Clinical Center America's Research Hospital

- Acute care hospital and ambulatory care center with over 650 direct care CRNs
- An additional 275 RNs work with investigators as research nurse coordinators
- 200 PAs/NPs provide direct care
- Staffed at a level to support precision in patient care and data collection
- Clinical care requirements are protocol-driven



Objectives

- Analyze the current state of genetics & genomics advances and how this impacts on today's clinical practice
- Review the basics of genetics & genomics in order to better understand how pharmacogenomic therapies & tests impact on patients.
- Dissect implications of direct-to-consumer genetic/genomic testing
- Identify ethical, legal, and social issues surrounding genetics & genomics testing and therapies.
- Identify and demonstrate facility with resources that can be used in everyday, busy clinical practice



What is Precision Medicine?

- Previously Personalized/Individualized Medicine
- NIH: an emerging approach for disease treatment and prevention that takes into account individual variability in genes, environment, and lifestyle for each person.
- Precision Medicine Initiative launched 1/2015 with a \$215 million investment in the President's 2016 Budget



Where do we stand now?



Views Of Primary Care Providers On Testing Patients For Genetic Risks For Common Chronic Diseases

- 488 PCPs in community/academic practices in NYC surveyed about their views on genetic testing for chronic diseases.
- The majority felt unprepared to work with patients at high risk for genetic conditions and were not confident about interpreting test results.

- [HEALTH AFFAIRS VOL. 37, NO. 5](#)

- [Diane Hauser, Aniwaa Owusu Obeng, Kezhen Fei, Michelle A. Ramos, and Carol R. Horowitz](#)
<HTTPS://DOI.ORG/10.1377/HLTHAFF.2017.1548>



Genetic/Genomic Testing?



Current Medical Practice

Medicine of the present: one treatment fits all



- After diagnosis, patients are prescribed therapy with no reference to the patient's genetic information
- “Trial and error” or
- “One size fits all”



One size does not fit all: Relative efficacy of drug and disease, according to Spear et al.

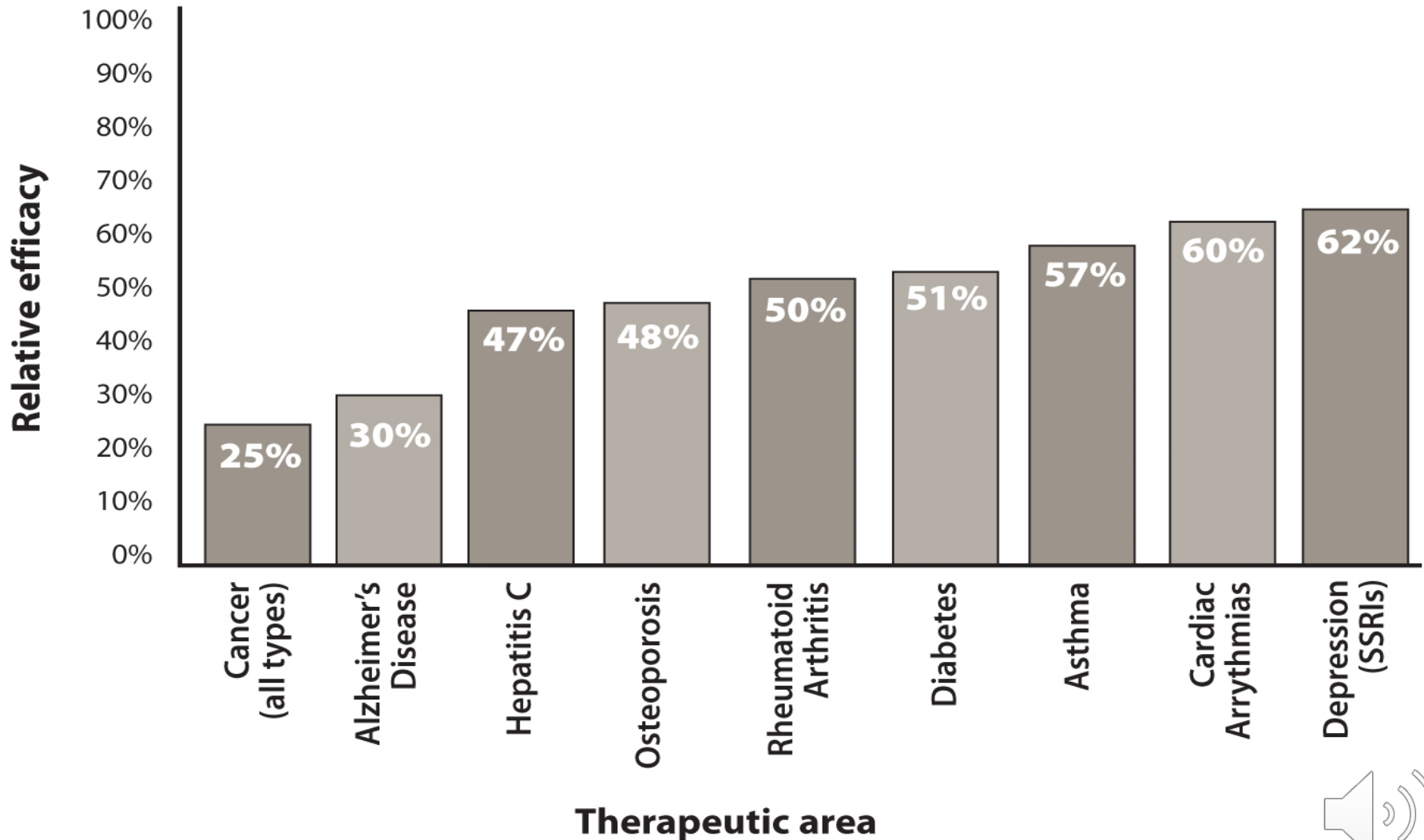

Adverse Drug Events

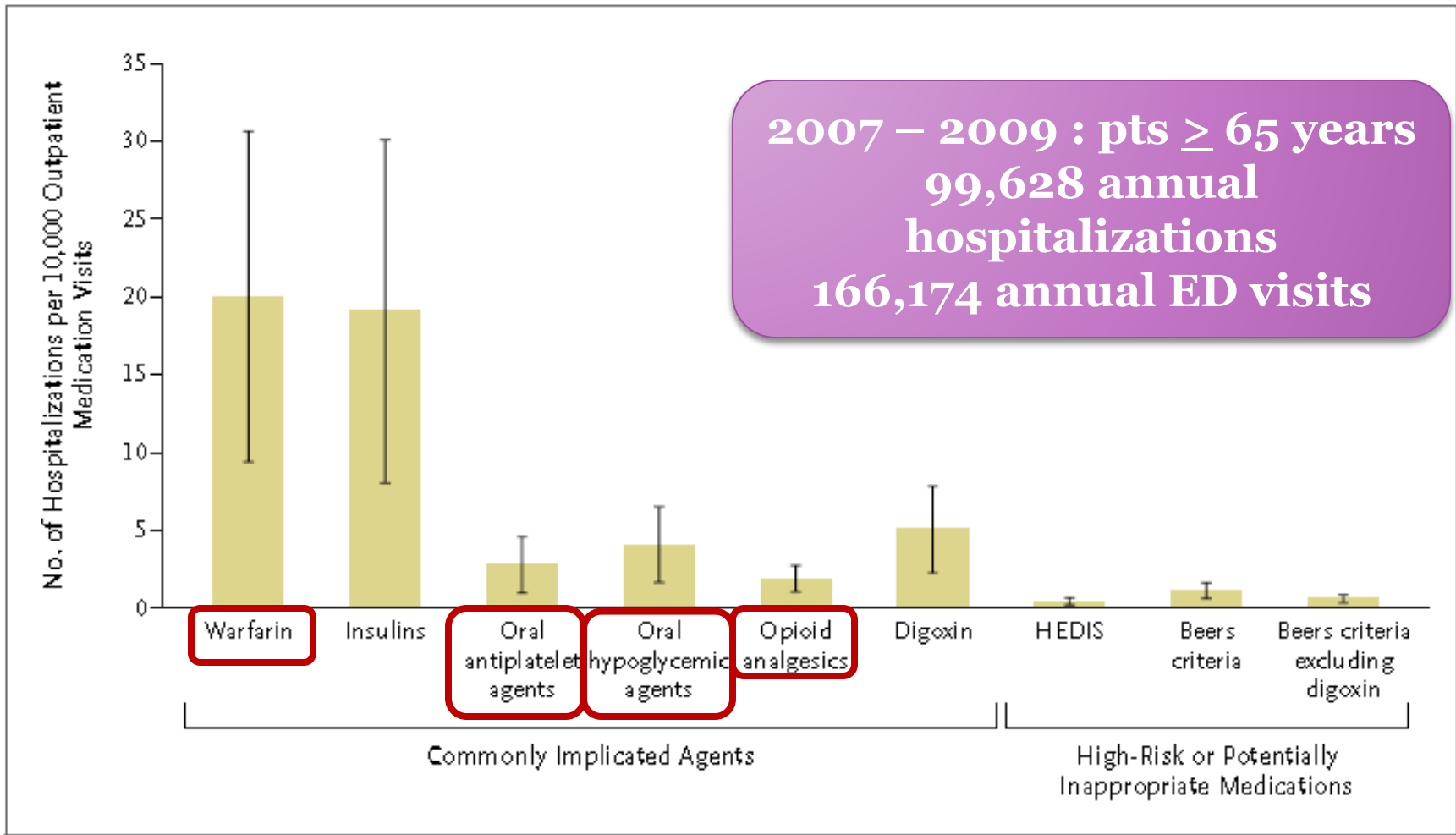

Figure 1. Estimated Rates of Emergency Hospitalizations for Adverse Drug Events in Older U.S. Adults, 2007–2009

Budnitz DS, Lovegrove MC, Shehab N, et al. NEJM 2011; 365: 2002

Why You Need to Know

- ~700 Conditions with Genetic Practice Guidelines
- Ever expanding market for direct-to-consumer marketing of gene testing/whole genome testing
- “New” Genetic/Genomic PA competencies
- To be the best PA you can be, of course!





A. Chis



Revised PA Genomic Competencies (September 2016)

Based on the 8 ACGME Domains

- Patient Care
- Medical Knowledge for Practice
- Interpersonal and Communication Skills
- Practice-Based Learning and Improvement
- Professionalism
- Interprofessional Collaboration
- Systems Based Practice
- Personal and Professional Development.

◦ Goldgar, C, Michaud, E, Park N, et al. Physician Assistant Genomic Competencies. *J Physician Assist Educ.* 2016;27:110-116.



5 “Genomic” EPAs per MD/DO grp

1. **Family History**: elicit, document, and act on relevant family history pertinent to the patient’s clinical status;
2. **Genomic Testing**: use genomic testing to guide patient management;
3. **Treatment Based on Genomic Results**: use genomic information to make treatment decisions;
4. **Somatic Genomics**: use genomic information to guide the diagnosis and management of cancer and other disorders involving somatic genetic changes;
5. **Microbial Genomic Information**: use genomic tests that identify microbial contributors to human health and disease, as well as genomic tests that guide therapeutics in infectious diseases.

• From: KorfB et al. Genetics in Medicine 2014;16 (11): 805-8



New PA Genomic Competencies

Patient Care

1. Gather family history information and construct a multigenerational pedigree.
2. Identify patients who would benefit from referral to genetics professionals.
3. Distinguish between genetic screening and genetic testing.
4. Incorporate genetic tests into patient management.
5. Discuss the range of genetic and genomic -based approaches to the treatment of disease.

Medical Knowledge for Practice

1. Describe the cellular and molecular mechanisms underlying human inheritance.
2. Define the role of genetic variation in health and disease.

Professionalism

1. Examine on a regular basis one's one competence in genomics pertinent to one's practice setting.

Interpersonal and Communication Skills

1. When communicating genetic information to patients, consider personal factors that may influence their understanding and response.
2. Explain the role of genetics professionals in the patient-care plan.
3. Promote informed decision making for patients, and provide nondirective counseling.
4. Offer appropriate psychological and social support to patients and families affected by a genetic condition.

Practice Based Learning & Improvement

1. Use information technology to obtain current and credible information about genetics for self, patients, and colleagues.

Interprofessional Collaboration

1. Seek coordination and collaboration with an interprofessional team of health care providers.

Systems-Based Practice

1. Identify key aspects of health care systems they apply to clinical genetics.



Genomics across the lifespan

- Preimplantation testing
- Prenatal
- Carrier testing
- Diagnostic testing/Children
- Diagnostic testing/Adult Onset
- Treatment decision testing
- Pharmacogenomics
- Recreational (Direct to Consumer)
- Whole Genome Sequencing
- After death...

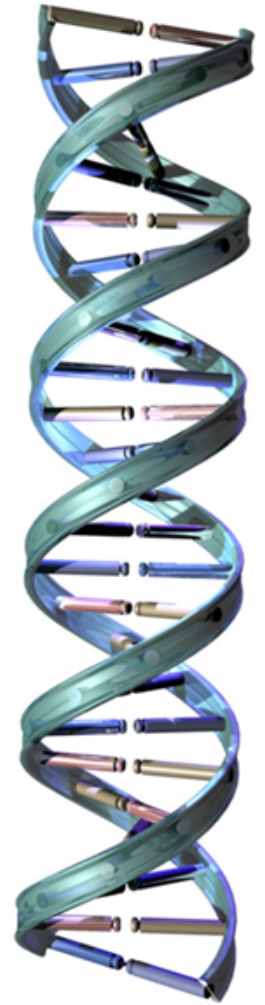

What is already being done now

- Newborn screening
 - Tests 29-50 severe, inherited, treatable genetic diseases
- Pathology testing of malignant tumors
- FDA approved/cleared 45 human genetic tests, and more than 100 nucleic acid-based tests for microbial pathogens.
- Infectious Disease testing
 - Ebola virus, drug-resistant strains of *Staphylococcus aureas* and *Klebsiella pneumoniae*, *Escherichia coli*, bacterial meningoencephalitis
- Whole genome or exome sequencing
 - CP misdiagnosis, but DNA sequencing pointed to a new diagnosis, as well as a treatment(dopa-responsive dystonia)
- Treatment of cystic fibrosis:
 - 4 % of cases caused by G551D mutation, treated with ivacaftor
- Fertility Treatment for Mitochondrial disease...





What Do You Know?

(Also known as everything you need to know, you already learned in PA school/college/PBS)

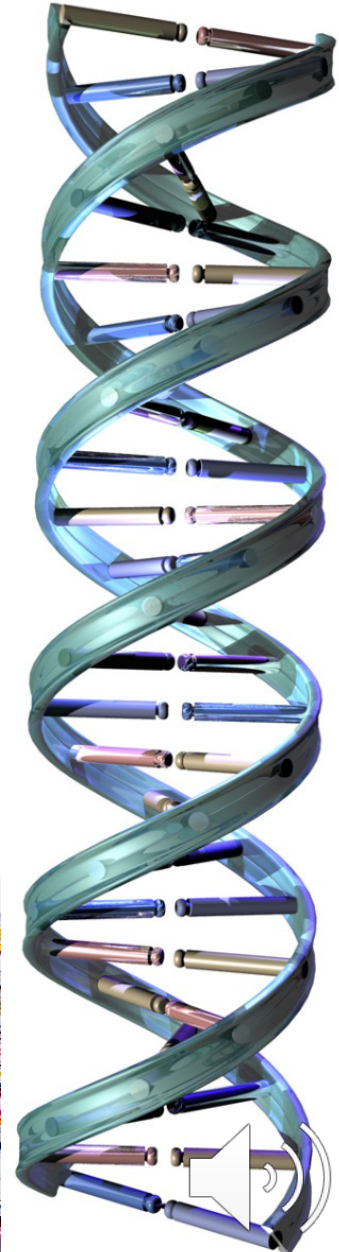

Just the basics

- DNA
- RNA
- Chromosome
- Genotype
- Phenotype
- Replication
- Mutation
- Variation
- Gene/Genetics
- Transcription/Translation
- Genome/Genomics
- Base pairs
- Mendelian Inheritance
- Recessive/Dominant
- Autosomal
- Sex-linked



COMPETENCY: Knowledge for Practice

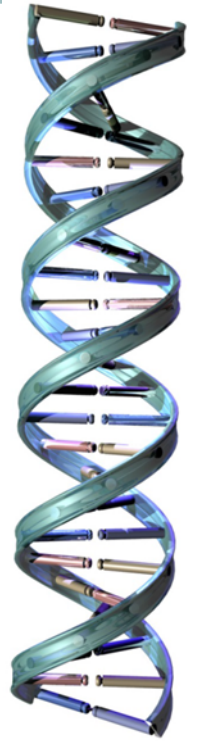

- Genetic terminology and nomenclature
- Cellular & molecular mechanisms underlying human inheritance
- Role of genetic variation in health and disease



Basic Terms

- Genome: All of the DNA in a cell
- Genomics: The study of genomes
- So each typical human cell contains ~6 billion genomic letters



The Human Genome: Your DNA

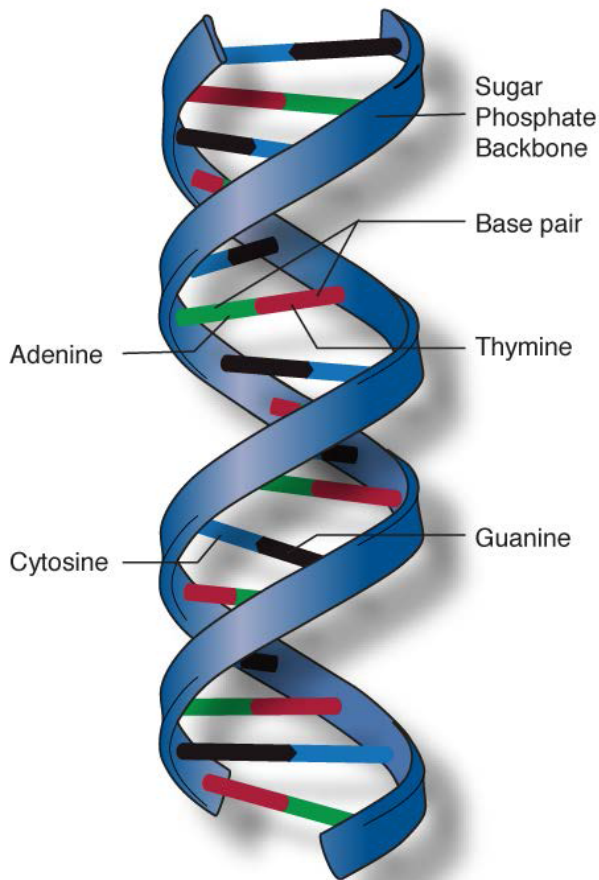

All the genetic material in the nucleus, plus the mitochondrial genome

Contain the coded instructions for how to build, maintain, and replicate a human being

Is not identical in anyone but identical twins

Always contain both benign variation & variation that can cause or contribute to disease

It's big! 3.3 Million base pairs (x2)



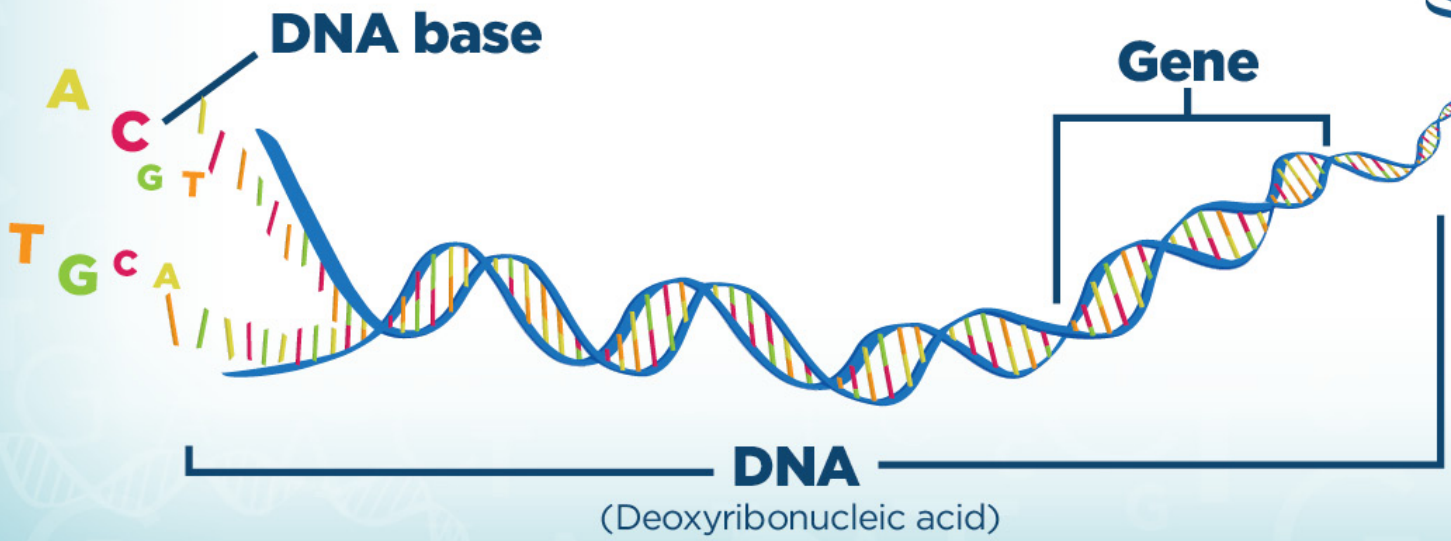
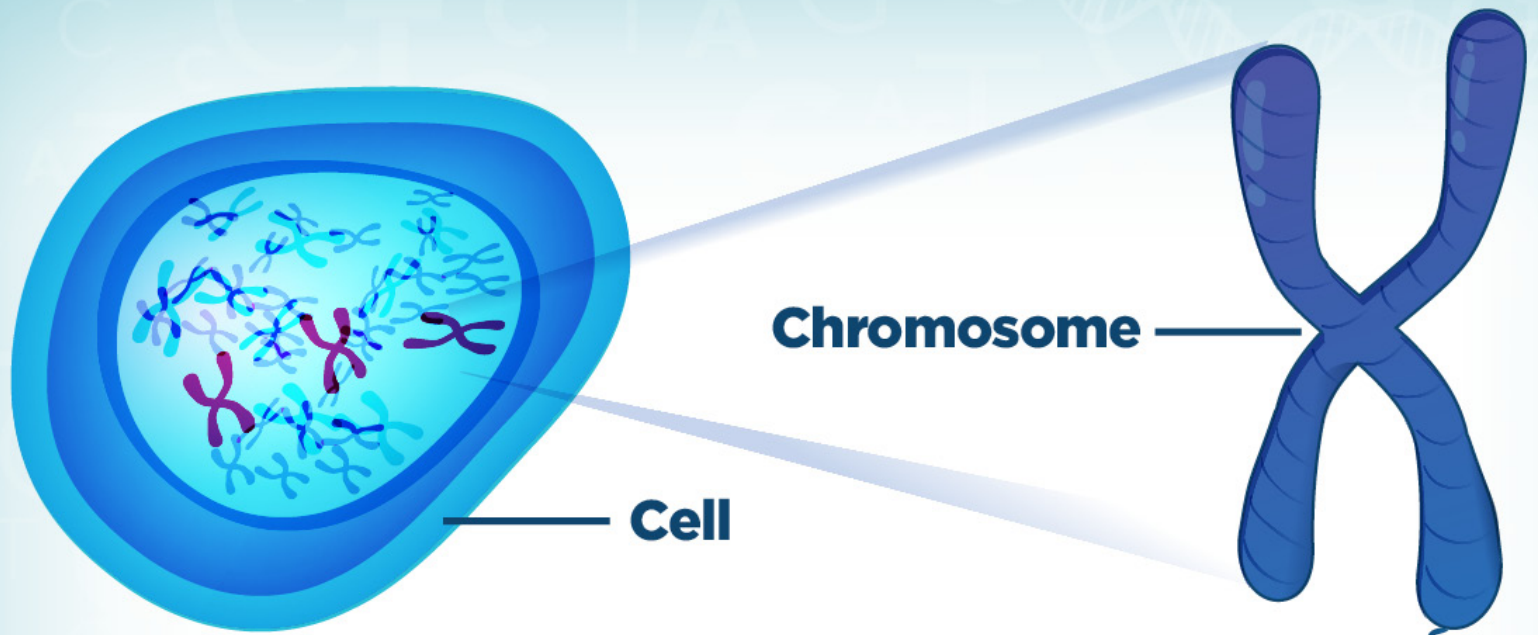

DNA-points to remember

- Double Helix = 2 strands
 - Which run in opposite directions

INFORMATION bases on each side ACGT
NOITAMROFNI

Double Stranded vs. Single Stranded (DNA/RNA)
2 Gene copies vs. 1 Gene copy
(Diploid vs. Haploid)





BOOK - GENOME

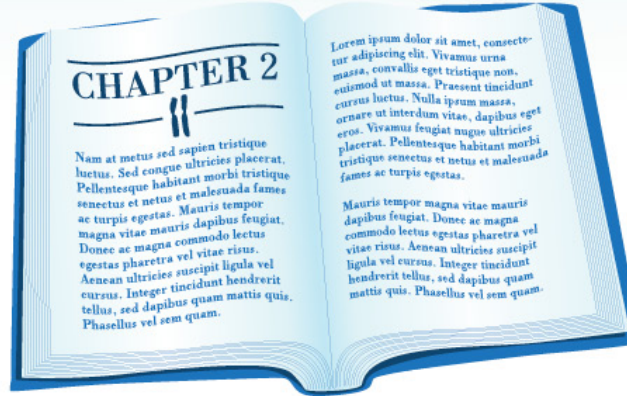

CHAPTERS - CHROMOSOMES

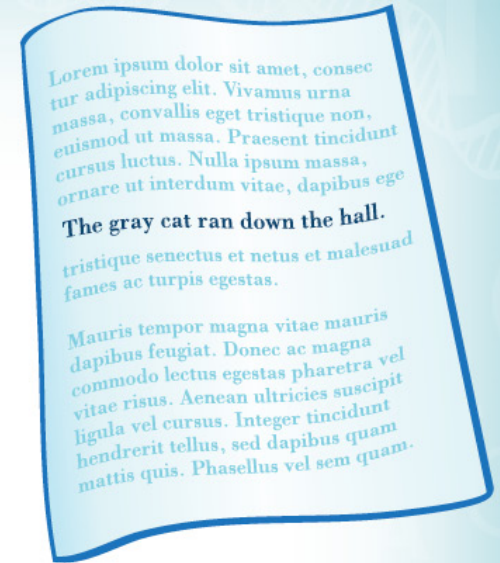

SENTENCE - GENE

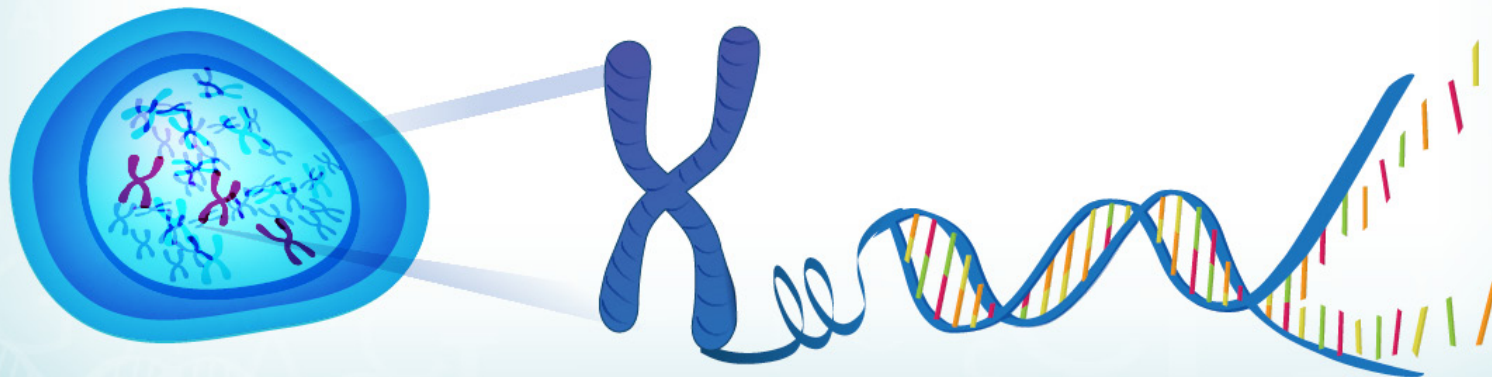

Genome Structure: Chromosomes

23 Pairs
--22 pairs of autosomes
-1 pair of sex chromosomes

They are packages of DNA with a consistent structure

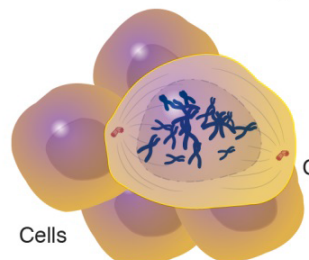
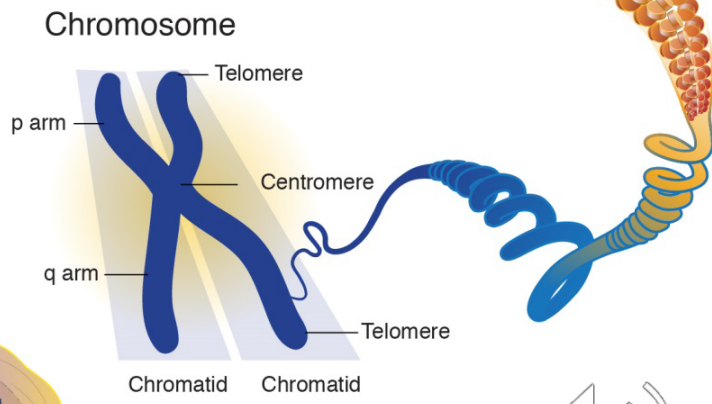
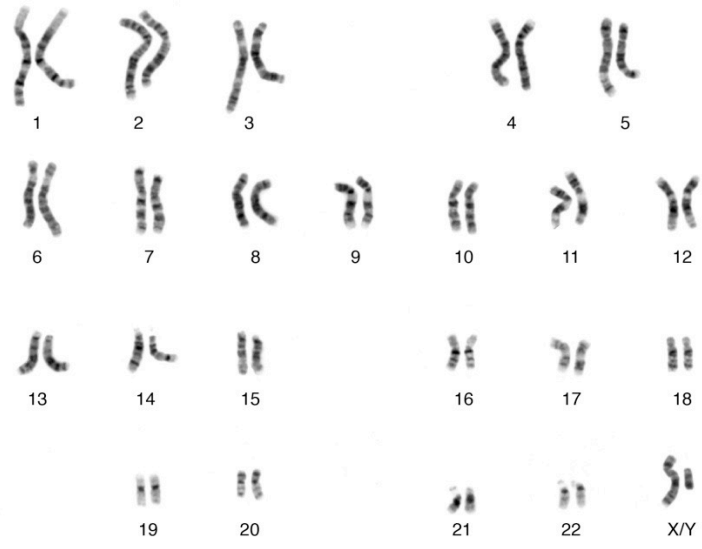
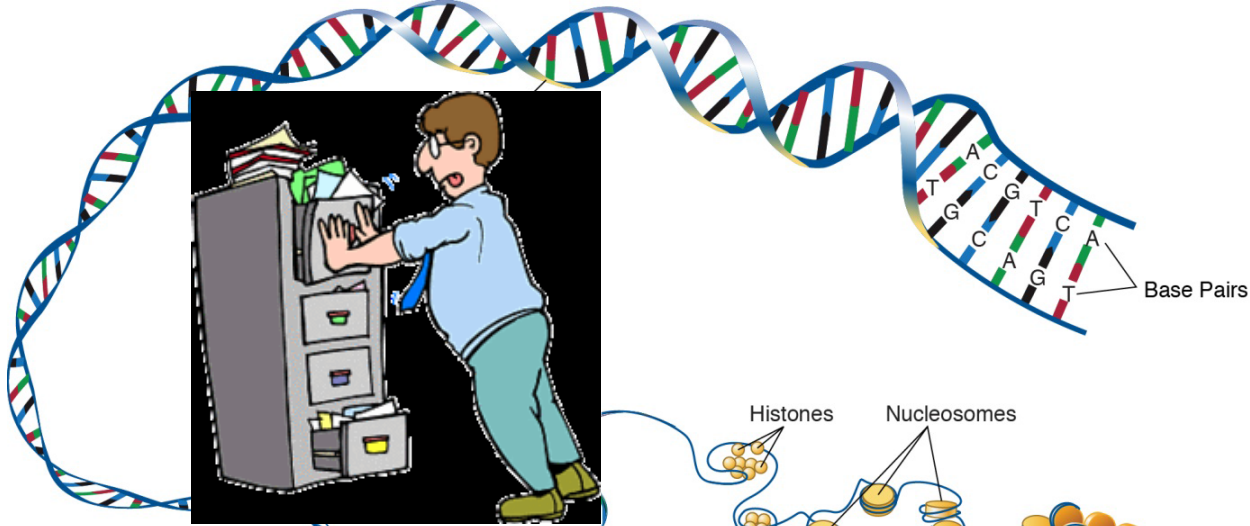

Cell during Prophase



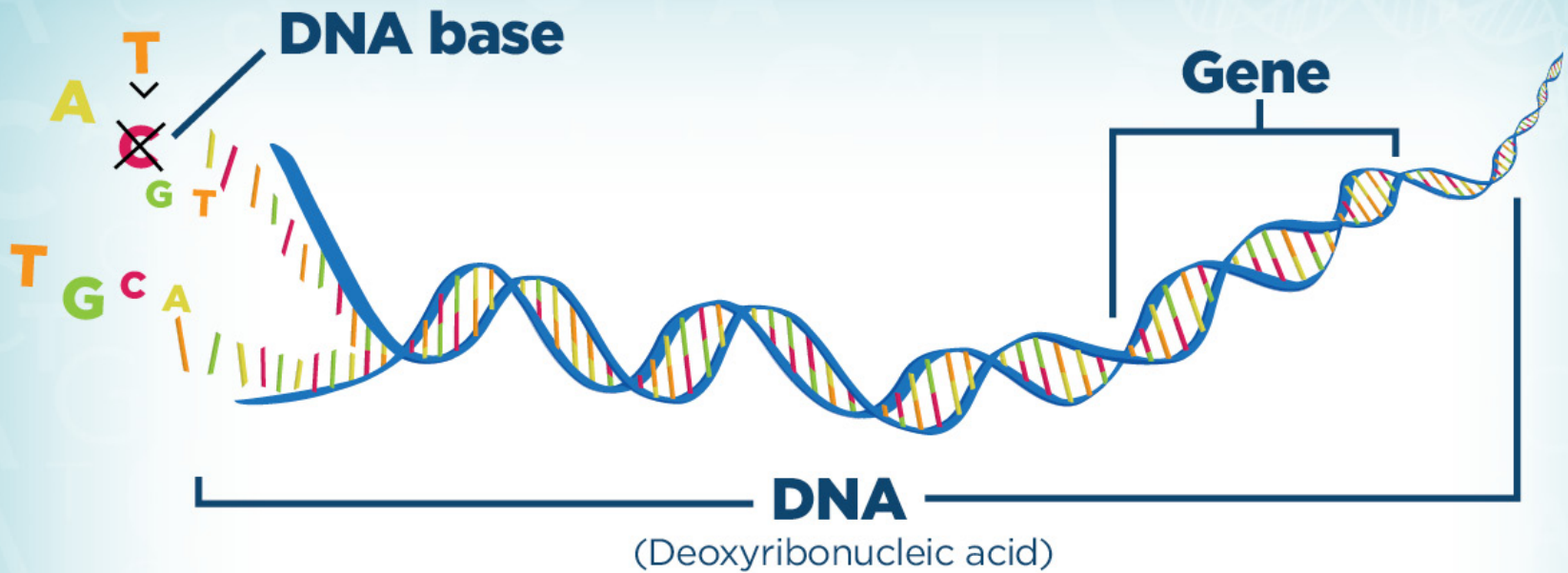

The gray cat ran down the hall.
The gray cat ran down the **b**all.

Changes in DNA might change the way a gene works.

Who does this affect?



No Mr. (or Ms.) Perfect

“We are all flawed mutants.”

• -Francis S. Collins, MD, PhD



- We all have these glitches in our DNA.
- 0.4 percent of variation distinguishes you from other members of our species.
 - Some glitches are significant, and others are not.



Variation

Originates
in one
member of
population.

Some
descendants
will inherit that
& pass it on.
Results in
frequency
differences in
different pop
lineages

Occurs
normally
without regard
to functional
consequence

Is
defined by
reference to a
“standard,”
which may or
may not be
“normal”

Is subject to
selective
pressures



VARIATION



The akiapola'au
forages for insects,
often under bark



The iiwi
feeds on nectar
from ohia flowers



The 'Apapane
feeds on insects
and ohia nectar



The Maui parrotbill
tears back bark in
search of beetles



The original species,
now extinct,
probably ate
insects and nectar



The Nihoa finch
uses its heavy bill
to crush seeds



The Amakihi
is a nectar-feeder,
like the iiwi



Not Synonyms of “Variation”

Mutation

- The molecular and chemical processes that result in new variation
- Otherwise avoid

Polymorphism

- Variation that exists in the “normal” population at 1% frequency or higher
- Assumed (not proven) to have no disease significance
- E.g. Single Nucleotide Polymorphism (SNP)

De novo (New)

- new variation (from mutation)
Altered between the last generation and this one

Marker

- Variation that is used to trace inheritance of DNA segments, or suggest linkage to disease genes. E.g. Linkage analysis



Mutation

Micro

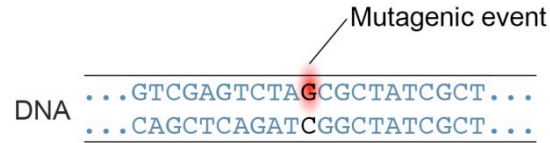

Deletion

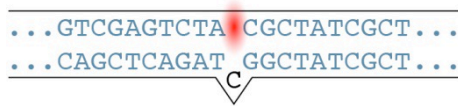

Insertion



Substitution



Macro

Deletion

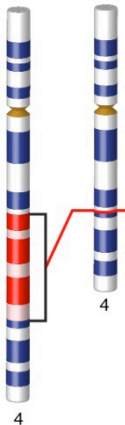

Duplication

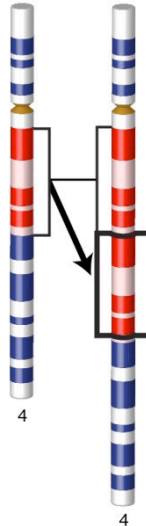

Inversion

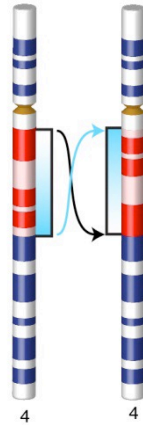

Substitution

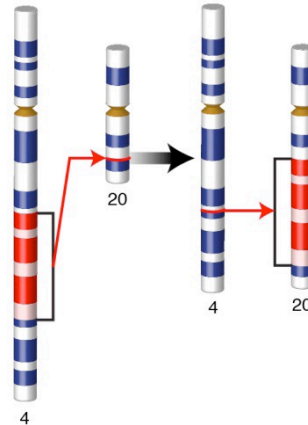

Translocation

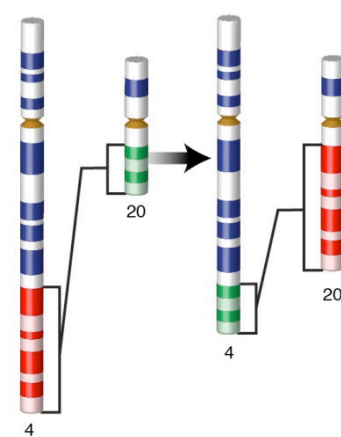

Oh, SNP

- Most common type of genetic variation is a single nucleotide polymorphism (SNP or “snip”)
 - See figure: Cytosine (C) changes to thymine (T) which changes the base pairs from cytosine and guanine (CG) to thymine and adenine (TA)
- SNPs alter a person’s ability to metabolize certain drugs

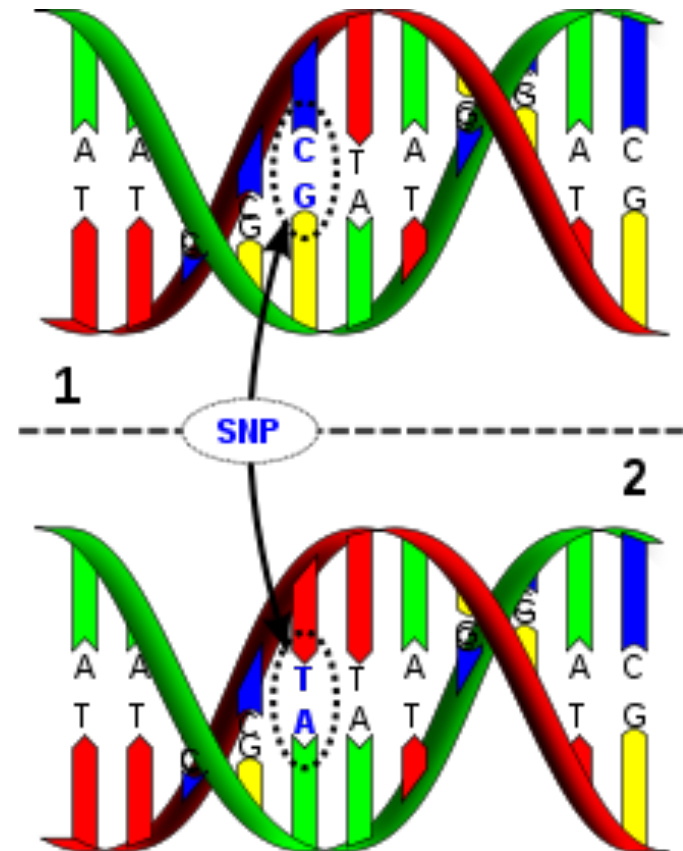

How We Name SNPs

- Phase 1 enzymes:

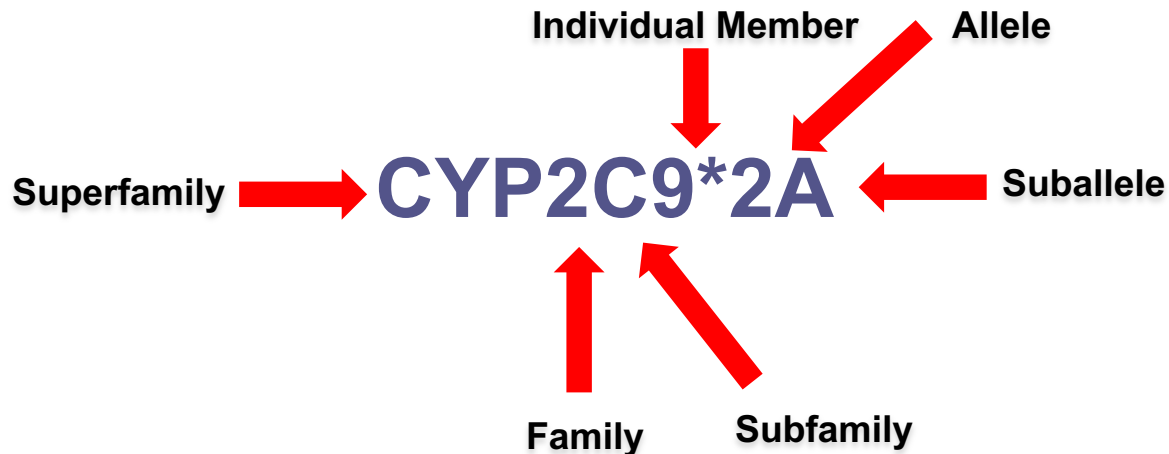

- Alleles are alternate versions of a gene
- *1 allele designation (CYP2C9*1) most commonly refers to the “wild type” or “normal” enzyme
- *2 or greater denote polymorphic alleles and are typically numbered in order of discovery-validation
 - Homozygous designation: **CYP2C9*1/*1** (two copies of wild-type allele)
 - Heterozygous designation: **CYP2C9*1/*2** (one copy of wild-type and one copy of reduced function allele)



Types of genetic variants

The gray cat ran down the hall. **Original**

The gray cat ran down the ball. **Missense**

The gray green cat ran down the hall. **Insertion**

The gray ____ ran down the hall. **Deletion**

The gray cat cat ran down the hall. **Duplication**

The gray. **Nonsense**

Direct-to-Consumer Testing

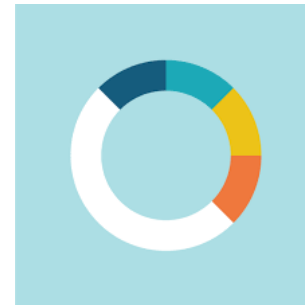

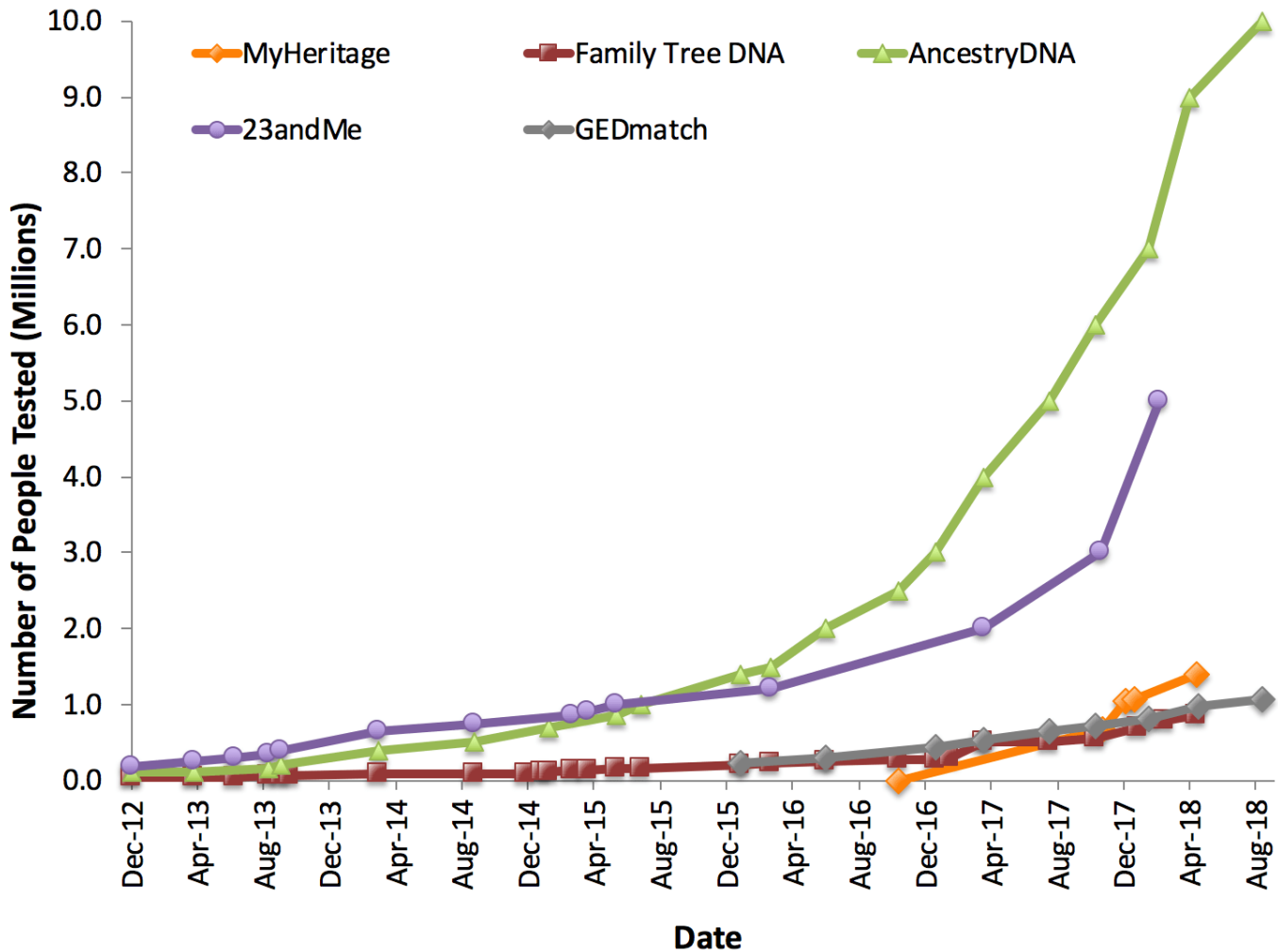

© 2018 by Leah Larkin, www.theDNAgeek.com. Sources: Company press releases (AncestryDNA, 23andMe, MyHeritage), ISOGG wiki "Autosomal DNA testing comparison chart" edit history (FTDNA), personal communications (GEDmatch)

Consumer genomic databases rapidly growing



Exponential Growth in DTC testing

- By the start of 2019, more than 26 million consumers had added their DNA to 4 leading commercial ancestry and health databases
- If the pace continues, the gene troves could hold data on the genetic makeup of more than 100 million people within 24 months.



DNA testing companies (as of 5/29/2020)

- [23andMe](#) (admixture, adoption, deep ancestry, genealogy) (health and trait reports also available in some countries)
- [23mofang](#) (admixture, deep ancestry, health and traits) A company catering for the Chinese market
- [24 genetics](#) (admixture, exome sequencing, health, paternity, pharmacogenetics, whole genome sequencing) A company catering for the Spanish market
- [African Ancestry](#) (deep ancestry)
- [AncestrybyDNA](#) (admixture, deep ancestry)
- [AncestryDNA](#), a subsidiary of Ancestry.com (admixture, adoption, genealogy)
- [Centrillion Biosciences](#) (aka TribeCode) (admixture, deep ancestry)
- [Dante Labs](#) (exome sequencing, health, whole genome sequencing) A test aimed at the European market
- [DNA Ancestry and Family Origin](#) ([FTDNA](#) affiliate in the Middle East) (admixture, adoption, deep ancestry, full mtDNA sequencing, genealogy)
- [DNA Worldwide](#) (formerly a [FTDNA partner](#). See also [Living DNA](#))
- [Family Tree DNA](#) (admixture, adoption, deep ancestry, full mtDNA sequencing, genealogy, Y chromosome sequencing)
- [Full Genomes Corporation](#) (whole genome sequencing, Y-chromosome sequencing)
- [Gene by Gene](#) - the parent company of [Family Tree DNA](#) which now incorporates the companies previously known as DNA Traits, DNA DTC and DNA Findings (research, health, exome sequencing, whole genome sequencing)
- [Genebase](#) (deep ancestry, genealogy)
- [Genera](#) ([FTDNA](#) partner in Brazil for ancestry tests) - also performs tests for paternity, fetal gender detection, pharmacogenetics, nutrition and physical traits
- [GenoTek](#) (admixture, genealogy, diet and fitness, family planning, health, talents and sports) A company catering for the Russian market
- [Genographic Project](#) (admixture, deep ancestry)
- [Genos Research Inc](#) (DTC whole exome sequencing; consumer focused healthcare big data spin out from Complete Genomics; Note: no genetic genealogy focus or tools)
- [Helix](#) (exome sequencing) US supplier of the [Genographic Project](#) Geno 2.0 Next Generation test
- [iGENEA](#) ([FTDNA](#) affiliate) (admixture, deep ancestry, genealogy)
- [Living DNA](#) (admixture, deep ancestry) See also [DNA Worldwide](#)
- [MyHeritage DNA](#) (admixture, genealogy)
- [Oxford Ancestors](#) (deep ancestry)
- [Roots for Real](#) (admixture, deep ancestry)
- [Sorenson Genomics](#) (laboratory services)
- [Sure Genomics](#) (whole genome sequencing and interpretation)
- TribeCode See [Centrillion Biosciences](#)
- [Veritas Genetics](#) (whole genome sequencing and interpretation)
- [WeGene](#) (admixture, deep ancestry, health, sports, traits) A test tailored for the East Asian market
- [YSEQ](#) (custom Y-SNPs, Y-STRs, SNP panels, whole genome sequencing)
- [Yoogene](#) (deep ancestry - YSTRs and mtDNA) A company catering for the Chinese market



At your local pharmacy



Photo credit: Linda Avey



Direct-to-Consumer Testing Costs

- 23 and me
 - \$99, \$199, and now \$499 VIP Health & Ancestry
 - “first and only genetic service available directly to you that includes reports that meet FDA standards for clinical and scientific validity.” 2015
- AncestryDNA \$99, AncestryHealth \$179

- Counsyl –dep on insurance

Requires a provider's order

- Color Genomics (WGS) \$249 +S&H
- Genos (WES)-not currently taking orders after joined NantOmics
- Veritas (WGS)-COVID-19 Testing only now (\$999)



Differences btw DTC Med Testing

- **23andMe:** does SNP genotype testing to look at 690,000 predetermined SNPs.
- **Genos:** examines the exome, the protein-producing portion of a person's DNA to catalog genetic variants
- **Veritas:** Whole genome sequencing (WGS) which reads nearly every letter in the genome, including portions in between genes that regulate gene activity and parts containing noncoding RNAs, which do a variety of cellular jobs



23andMe



1. Ancestry

- Proportion of DNA from 1000 regions worldwide
- DNA Relatives
- Neanderthal Ancestry

2. Ancestry & Health

- Wellness Report (5+)
 - Caffeine, Sat Fat/Wt, ETOH flush rxn, lactose, Muscle composition...
- Traits (25+)
 - Earwax type, back hair (men), dimples, toe length ratio....
- Carrier Status Report (40+ conditions)
 - CF, Nonsyndromic Hearing Loss & Deafness, Sickle Cell...
- Health Predispositions (10+)



23andMe Health Predispositions

REPORT	GENE(S)	VARIANTS	RELEVANT ETHNICITIES
BRCA1/BRCA2 (Selected Variants)	BRCA1 and BRCA2	3	Ashkenazi Jewish
Age-Related Macular Degeneration	ARMS2 and CFH	2	European
Alpha-1 Antitrypsin Deficiency	SERPINA1	2	European
Celiac Disease	HLA-DQB1 and HLA-DQA1	2	European
Familial Hypercholesterolemia	LDLR and APOB	24	All populations
G6PD Deficiency	G6PD	1	African
Hereditary Hemochromatosis (HFE-Related)	HFE	2	European
Hereditary Thrombophilia	F2 and F5	2	European
Late-Onset Alzheimer's Disease	APOE	1	All populations
Parkinson's Disease	LRRK2 and GBA	2	European, Ashkenazi Jewish, North African, Berber

NEW! DM, Type 2 (23andMe research)



What happens to all the data?

On average, a customer who chooses to opt into research contributes to over 230 studies on topics that range from Parkinson's disease to lupus to asthma and more.



23andMe Data “Collaborators”

ACADEMIC:

- University of Chicago
- MRC Epidemiology Unit at Cambridge University
- Broad Institute of MIT and Harvard
- Stanford University

INDUSTRY:

- Alnylam Pharmaceuticals, Inc.
- Biogen
- Genentech
- Pfizer
- P&G Beauty

NON-PROFITS:

- Lupus Research Institute
- The Michael J. Fox Foundation
- National Parkinson Foundation
- Parkinson's Institute and Clinical Center



NYT Editorial Rebuttal (2/5/2019)

- “We believe that consumers can learn about genetic information without the help of a medical professional, and we have the data to support that claim...Many people do not meet the criteria for diagnostic testing through their medical professional, thus inhibiting access.”
 - -Anne Wojcicki, Chief executive and co-founder of 23andMe



Ancestry.com



- DNA analyzed at more than 700,000 genetic markers
- 26 Ethnic Regions
- Database of more than 2 million people since 1980s
 - Billions of historical records and millions of family trees
- 7/16/2015: launched AncestryHealth
 - Free platform to record several gen family hx
 - 6 mo membership \$99, 12 mo \$189



Race: A Cautionary Tale

Global Frequency of HLA-B*5701

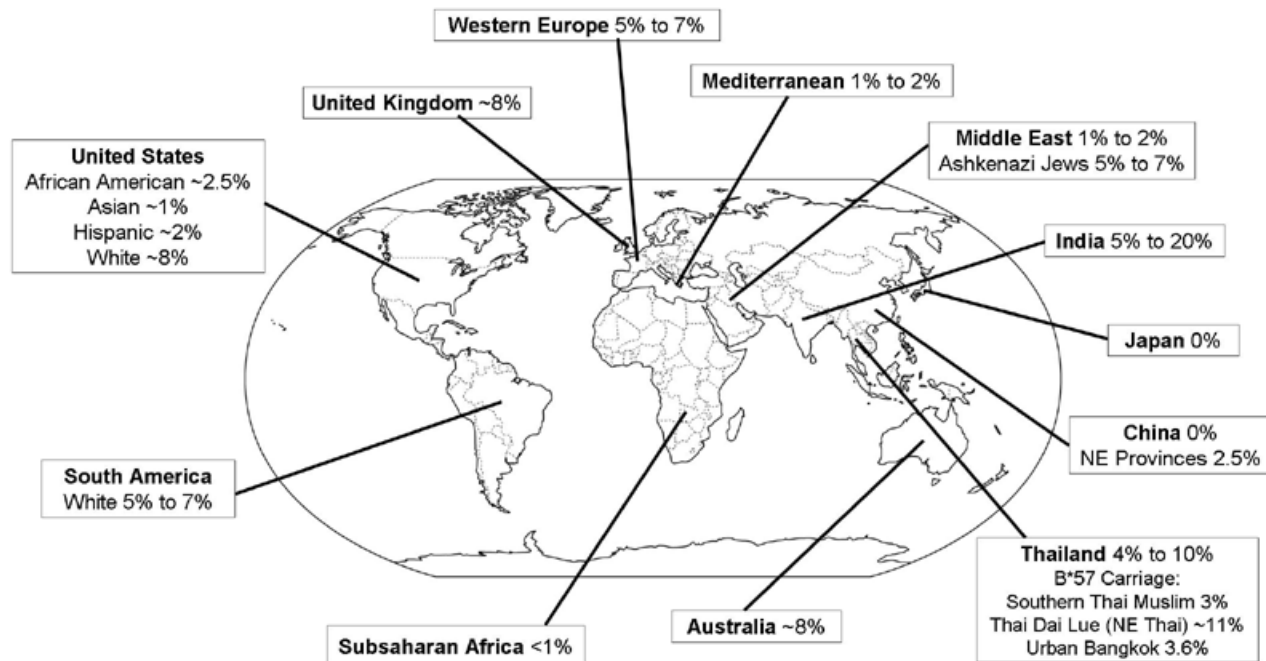

Adapted from David Nolan et al. J HIV Ther. 2003 May;8(2):36-41.



Veritas (before pandemic)

- Insights on **200+** conditions selected on the basis of actionability and ACMG 59
- **40+** carrier conditions
- Review of clinically-actionable findings with a [genetic counselor](#)
- **15** diseases included in Veritas [Risk](#) panel
- Drug sensitivities on **150+** [drugs](#)
- **50+** [traits](#) related to nutrition, longevity and more
- Ancestry by region



Color Genomics



- Provider-ordered
- \$249
 - Tests 30 genes associated with hereditary cancers including BRCA1/BRCA2 (\$199)
 - Tests 30 genes associated with genetic forms of heart disease (including high cholesterol)
 - Analysis of 14 genes associated with medication response
- \$50 each
 - Family Testing Program for pts w/ positive test



What causes “The Big C”?

Hereditary cancer is caused by an inherited genetic mutation.

Typically recurring pattern of cancer across 2 to 3 generations
Multiple individuals diagnosed with the same type of cancer(s) or individuals diagnosed with cancer much younger than average.

Familial cancer appears to occur more frequently in families than is expected from chance alone.

No specific mutation has been linked to these cancers, but may have a hereditary component that has not yet been identified.

Sporadic cancer occurs due to spontaneous mutations that accumulate over a person’s life.

Cannot be explained by a single cause.

Several factors, such as aging, lifestyle, or environmental exposure, that may contribute to the development of sporadic cancer.



Counsyl/Myriad Women's Health

- Ordered by patient's provider
- Works with insurance companies, cost varies
- Family Prep Screen, family planning/PGD
 - 175+ inherited disorders (diverse pop)
- Informed Pregnancy Screen, Noninvasive
 - 12 conditions
 - Microdeletion & sex chromosome screen
add'l/dependent on
- Inherited Cancer Screen
 - Looks at up to 36 genes assoc w/ inc risk of certain cancers.



Hacking your own DNA report

- Sequencing.com is an 'open' platform for apps that transform genetic data into meaningful information.
- It doesn't matter where you had genetic testing: you can store, share and use your genetic data here.
- Sequencing.com is fully compatible with all genetic data formats
 - [upload genetic data from *any* genetic test](#)
- The apps in our [App Market](#) are compatible with genetic data obtained from *any* genetic test including whole genome sequencing, exome sequencing and microarrays (DNA chips).
 - [Includes DNA data from 23andMe, Ancestry, MyHeritage, FamilyTreeDNA, LivingDNA, Vitagene, Macrogen, Fulgent, Illumina, Affymetrix, Helix, Human Longevity Inc., GeneDx, WuXi Nextcode, BGI and all other genetic testing companies and laboratories.](#)



Updated Genetic/Genomic PA Competencies, 2016

- Medical Knowledge for Practice
- Patient Care
- Professionalism
- Interpersonal and Communication Skills
- Practice Based Learning and Improvement
- Interprofessional Collaboration
- Systems-based Practice



COMPETENCY: Patient Care

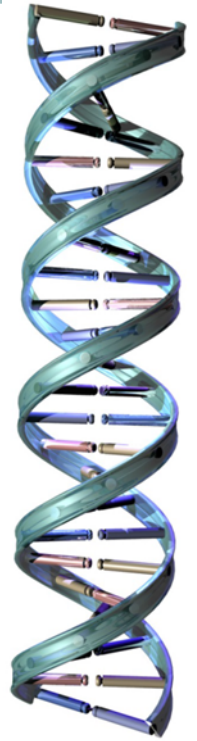

- Gather family history to create a pedigree
- Assess the pedigree for risk
- Differentiate genetic screening from genetic testing.
- Incorporate genetic tests appropriate to setting into patient care



What do you need to know?

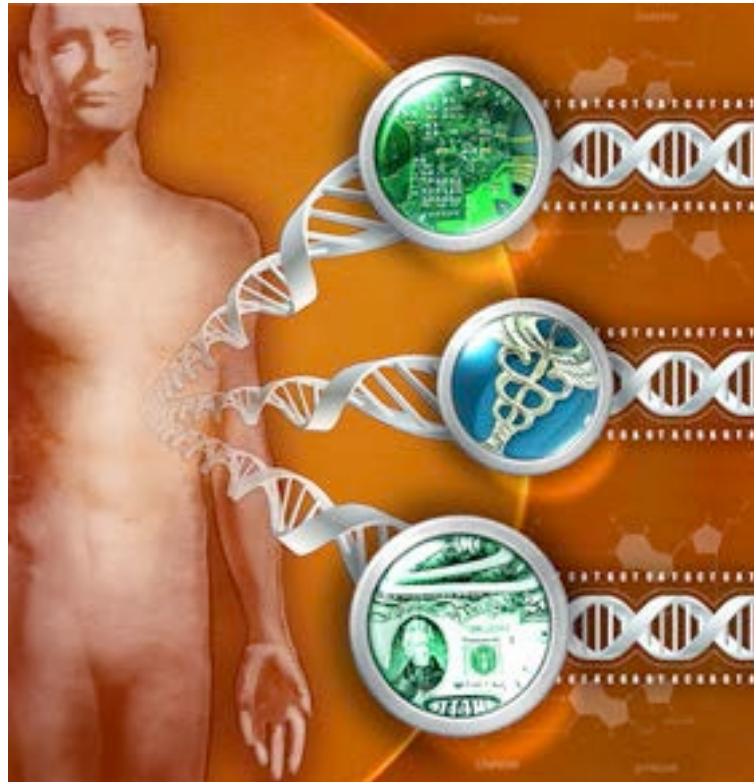

What we already do

- FAMILY HISTORY, FAMILY HISTORY, FAMILY HISTORY!
- Another test that we frequently already order that can reveal familial/genetic info?



What we already do

Another test that we frequently already order that can reveal familial/genetic info?

- Cholesterol profile
 - Familial hypercholesterolemia



FAMILY HISTORY

CDC study:

- <30 % of Americans have actively collected health information from their relatives.
- 96% believe this information is important to know.
- Limitations



Pedigree

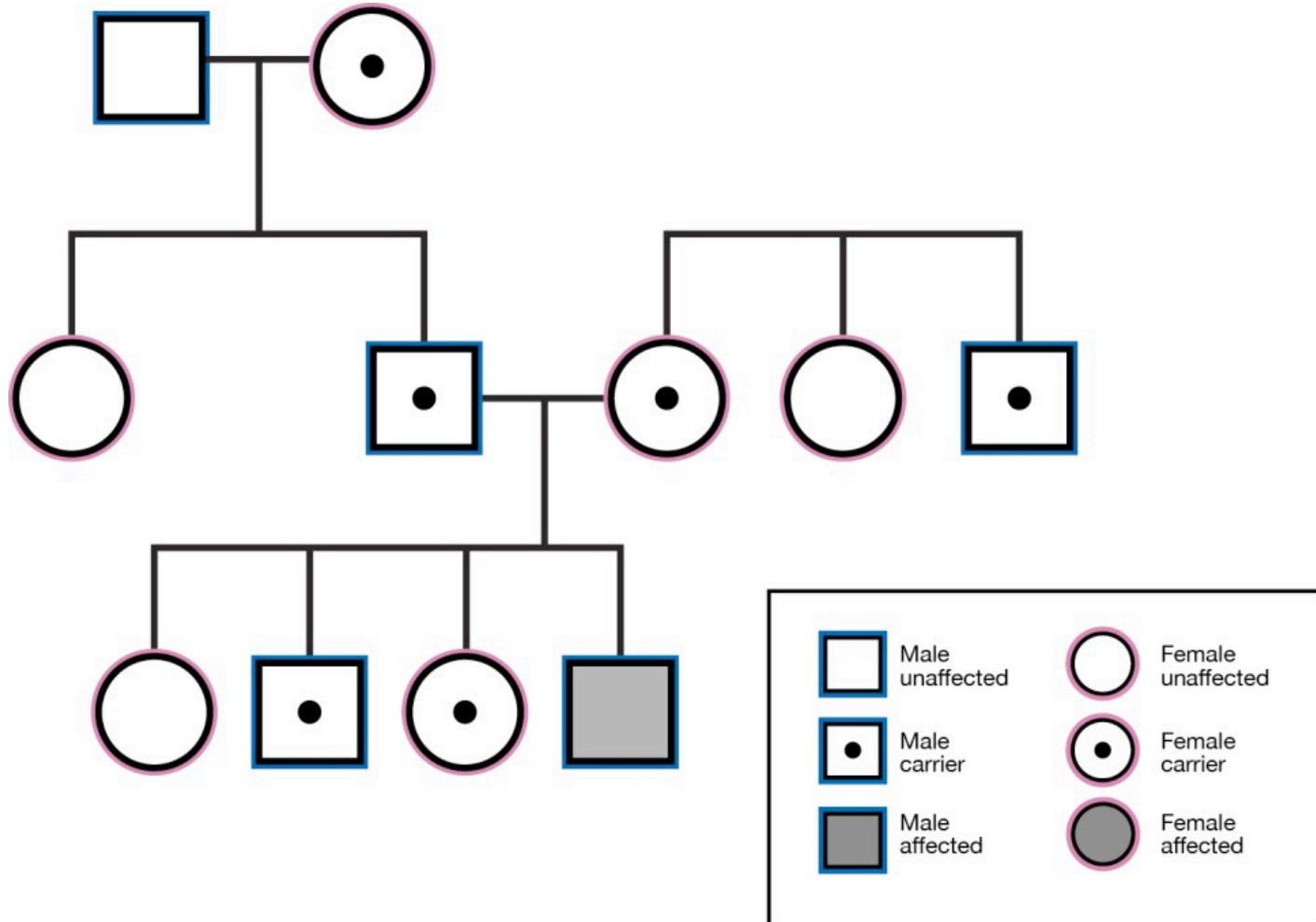

Family History Requirements-3 Gen

- Pt (Proband or Consultand)
- 1st-degree relatives (children, siblings, parents)
- 2nd-degree relatives (half-siblings, aunts, uncles, grandparents, nieces & nephews)
- Sometimes 3rd-degree relatives (first cousins, half-aunts and half-uncles)
- Include maternal and paternal sides of the family
- Degree of relationship, including: full or half siblings, children with same or different partner(s)
- Affected and unaffected relatives
- Date of collection (or date of update), and the name of collector (or updater)
- Legend or key in pedigrees, if symbols are used to designate disease



But wait! There's more. . .

- Age or year of birth (approximate ages appropriate for distant relatives or when exact ages are not known)**
- Relevant health information, including test results if applicable
- Diagnosis and age at diagnosis
- Age at death and year if known
- Cause of death
- Ancestral background for each biological grandparent
- Infertility, or no children by choice
- Pregnancies
- Pregnancy complications with gestational age noted, including miscarriages, stillbirths, ectopic pregnancies, pregnancy terminations, preterm birth, preeclampsia, and bleeding/clotting complications
- Consanguinity (blood relationship of parents, for example first cousins)



My Family Health Portrait

A tool from the Surgeon General

The Take-Home Exam:

<https://familyhistory.hhs.gov/FHH/html/index.html>

In the Office Exam:

<http://www.ama-assn.org/ama/pub/physician-resources/medical-science/genetics-molecular-medicine/family-history.page>

Thanksgiving is Family History Day!



Next Step: Screening or Testing?

SCREENING

- Testing done on a particular population
- Individuals are asymptomatic
- Not designed to diagnose, simply to identify individuals at higher risk
- May lead to diagnostic tests

TESTING

- Testing done on individuals
- Individuals are often symptomatic
- Individuals may have had a positive screening test
- May lead to treatment options



Meet Mr. C

- 54 year old male presented to the cardiac catheterization laboratory for a left heart cath due to an abnormal stress treadmill study/CP
- PMH:
 - Hypercholesterolemia, DM, HTN
- Intervention:
 - PTCA/stent to mid-Cx
- PGx:
 - PA ordered PGx test but sample was not collected
- Patient discharged on clopidogrel 75 mg and aspirin 81 mg daily



CYP2C19 and Clopidogrel

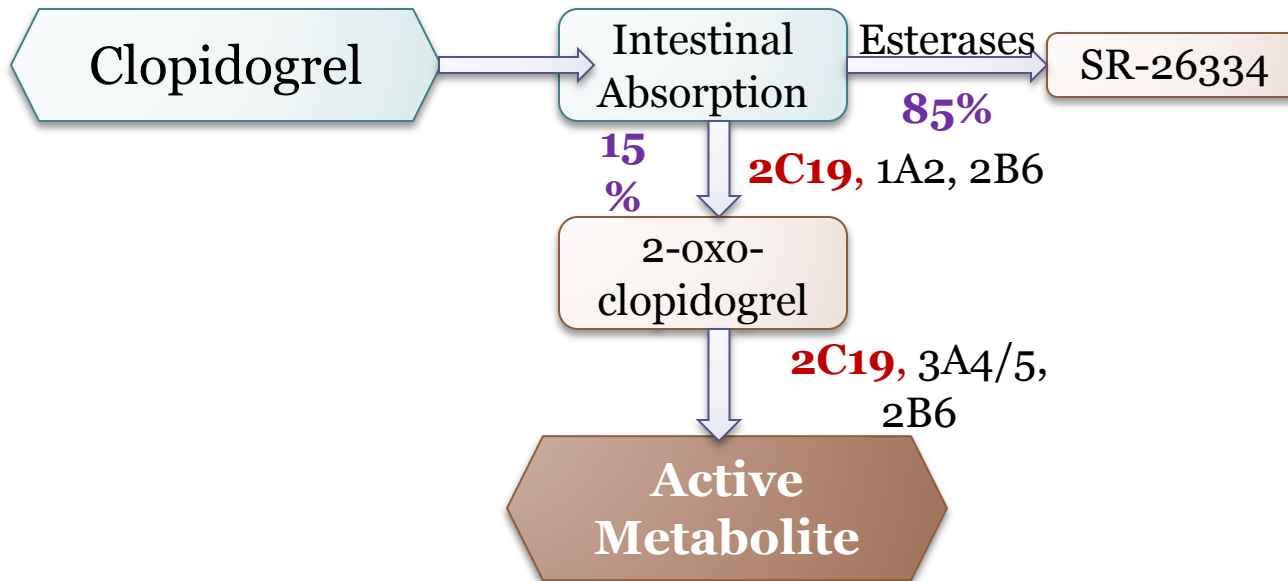

Cytochrome P450 2C19

- CYP2C19 is a hepatic enzyme
- Metabolizes ~5-15% of all prescription drugs
 - Non functional metabolic activity
 - CYP2C19 *2, *3, *4, *6, *7, *8
 - Decreased metabolic activity
 - CYP2C19 *9 & *10
 - Increased metabolic activity
 - CYP2C19 *17



CYP2C19 Genotypes and Phenotypes

Phenotype	Genotype/ Activity	Diploypes Examples	Population Frequency
Ultra-rapid metabolizer (UM)	Carrier of two increased activity alleles OR one normal plus one increased activity allele	*17/*17; *1/*17	~5 – 30%
Extensive metabolizer (EM)	Wild type (carrier of two normal function alleles)	*1/*1	~ 35 – 50%
Intermediate metabolizer (IM)	Carrier of one functional and one loss of function OR one loss of function and one increased activity allele	*1/*2; *2/*17	~18 – 45%
Poor metabolizer (PM)	Carrier of two loss of function alleles	*2/*2; *3/*3	~ 2 – 15%



CYP2C19 Polymorphisms and Response to Clopidogrel

Risk of death from CV causes, MI or CVA

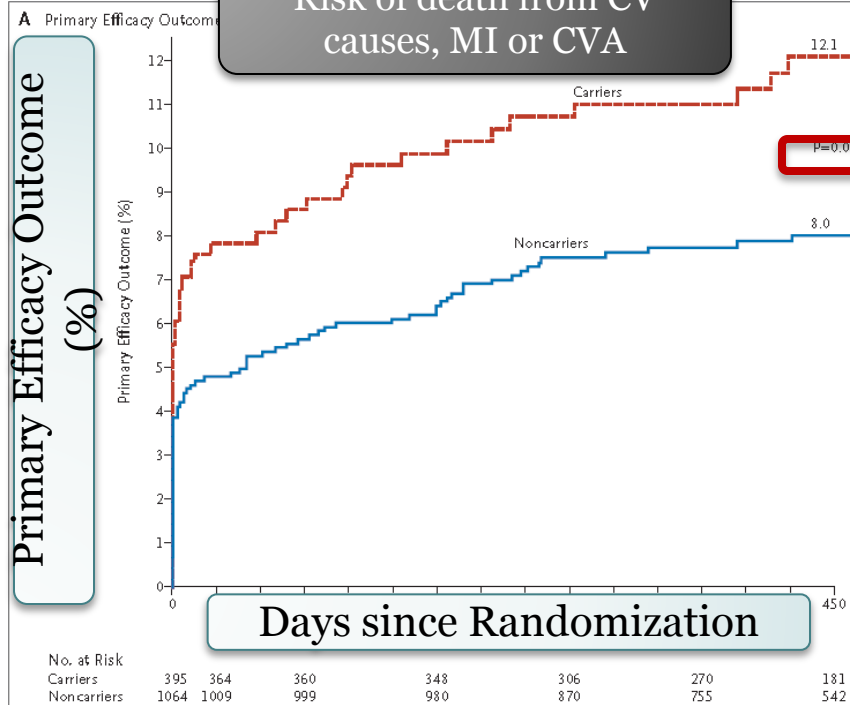

Stent Thrombosis

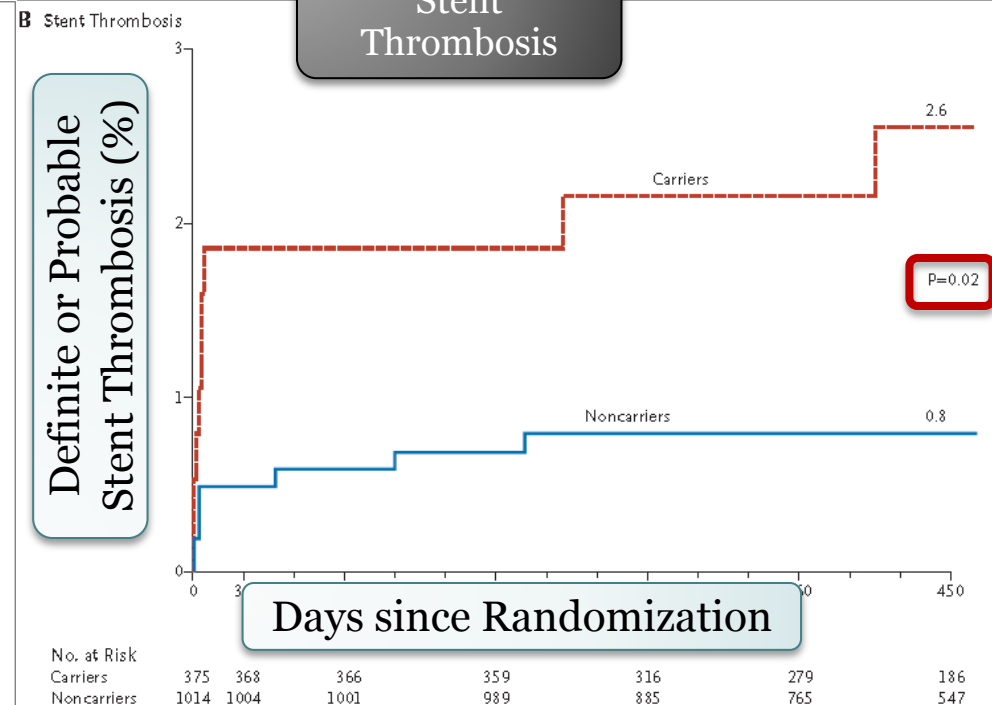

Carriers of a reduced-function *CYP2C19* allele have significantly lower levels of the active metabolite of clopidogrel, diminished platelet inhibition, and a higher rate of major adverse cardiovascular events, including stent thrombosis.



CYP2C19-Guided Antiplatelet Therapy

Phenotype	Clinical Implications on Clopidogrel	Therapeutic Recommendations	Level of Recommendations
Ultra-rapid Metabolizer	Increased platelet inhibition	Use clopidogrel at label recommended doses	Strong
Extensive Metabolizer	Normal platelet inhibition	Use clopidogrel at label recommended doses	Strong
Intermediate Metabolizer	Reduced platelet inhibition, increased risk of adverse CV events	Use alternative antiplatelet therapy (i.e. prasugrel or ticagrelor if not contraindicated)	Moderate
Poor Metabolizer	Significantly reduced platelet inhibition, increased risk of adverse CV events	Use alternative antiplatelet therapy (i.e. prasugrel or ticagrelor if not contraindicated)	Strong



Mr. C continued

- Presented to emergency room 2 days after discharge
 - **CC:** Substernal chest pressure radiating to jaw w/ assoc diaphoresis
- Intervention:
 - 2 overlapping DES to the RCA
- PGx Team:
 - Followed up with team the next day to reorder PGx
 - A day later the PGx test was reordered and sample collected
- Discharged on day 4 on clopidogrel 75mg and ASA 81mg QD still awaiting PGx results
 - PGx test results: ***2/*2 (poor metabolizer)** day 5!
 - Clopidogrel was changed to prasugrel 10mg daily

Partial list of medications

- allopurinol
- amitriptyline
- citalopram
- clopidogrel
- codeine
- dextromorphan
- escitalopram
- fluoxetine
- nortriptyline
- paroxetine
- phenytoin
- tramadol
- venlafaxine
- warfarin

Pharmacogenomic help

- Medical Genetics Summaries:

<http://www.ncbi.nlm.nih.gov/books/NBK109194>

Medical Genetics Summaries

- Concise reviews about genetic influence on drug responses
- Includes genetic testing strategy and dosing recommendations
- Expert-reviewed
- Regularly updated
- Free to access
- Integrated with GTR and MedGen



Get dosing recommendations by genotype

Example: Codeine metabolism is influenced by *CYP2D6* variations. A standard dose may provide inadequate pain relief in some and severe toxicity in others. MGS contains therapeutic recommendations based on *CYP2D6* genotype, such as when to alter the dose or use an alternative drug.

Avoid idiosyncratic drug reactions

Example: Allopurinol is used in the treatment of gout but it may cause drug-induced severe cutaneous adverse reactions (SCAR). There is a strong association between *HLA-B*58:01* and SCAR. MGS includes therapeutic recommendations that warn not to prescribe allopurinol to *HLA-B*58:01* carriers.



Medical Genetics Summaries [Internet].

[< Prev](#)[Next >](#)[▶ Show details](#)[Contents](#) 

Atomoxetine Therapy and *CYP2D6* Genotype

Laura Dean, MD.

NCBI

dean@ncbi.nlm.nih.gov

Created: September 10, 2015.

Atomoxetine was the first non-stimulant drug to be used in the treatment of attention-deficit hyperactivity disorder (ADHD). Atomoxetine is a selective noradrenaline reuptake inhibitor, and is part of a treatment plan for ADHD that may include other measures such as psychological, educational, and social support.

The *CYP2D6* enzyme metabolizes a quarter of all prescribed drugs, including atomoxetine. Individuals who carry two nonfunctional copies of the *CYP2D6* gene are known as poor metabolizers and have higher plasma concentrations of atomoxetine compared with individuals who have two copies of normal activity alleles.

The FDA states that the dose of atomoxetine may need to be adjusted in patients known to be *CYP2D6* poor metabolizers (1). A guideline from The Dutch Pharmacogenetics Working Group includes the recommendation that poor metabolizers can be given the standard dose of atomoxetine, but physicians should be aware of adverse drug events. They also state that for individuals who have more than two functional gene copies of *CYP2D6*, i.e., individuals with so-called ultrarapid metabolizer status, physicians should either be alert to reduced efficacy with the standard dose of atomoxetine, or they should prescribe an alternative drug, such as methylphenidate or clonidine (Table 1) (2).

Types of genetic information relevant to patient care

- Conditions
 - MedGen has content for
 - 53,993 conditions that have one or more definitions
 - 677 conditions with genetics practice guidelines
- Genetic tests (Genetic Test Registry-GTR)
 - GTR has 35,000 genetic tests
 - 323 tests for 162 drug responses and 29 genes
 - 757 somatic / cancer tests
- Variations and their relationship to human health
 - ClinVar has 157,026 unique variation records for 27,213 genes
 - 143,913 variations with interpretations about pathogenicity

MedGen –

<http://www.ncbi.nlm.nih.gov/medgen>

MedGen

MedGen ▼

Search

Help

Condition

drug response

Clinical feature

Gene

OMIM #

etics, such as attributes of conditions

Using MedGen

[MedGen Quick Start](#)

[List of Professional Guidelines](#)

[Help](#)

[MedGen Chapter in The NCBI Handbook](#)

[Select condition and phenotype terms for ClinVar and GTR](#)

[Frequently asked questions](#)

[Downloads/FTP](#)

[MedGen News](#)

MedGen Tools

[1000 Genomes Browser](#)

[Variation](#)

Other Resources

[ClinVar](#)

[Gene](#)

[Genetic Testing Registry \(GTR®\)](#)

[GeneReviews®](#)

[OMIM®](#)

[RefSeqGene](#)

Find tests in GTR – from MedGen

MedGen [Limits](#) [Advanced](#) [Help](#)

Full Report ▾ Send to: ▾

Marfan syndrome (MFS)

MedGen UID: 44287 • Concept ID: C0024796 • Disease

Synonyms: FBN1-Related Thoracic Aortic Aneurysm and Dissection; MARFAN SYNDROME

Modes of inheritance: Autosomal dominant inheritance

SNOMED CT: Marfan syndrome (193571001)

Gene (location): FBN1 (15q21.1)

OMIM®: 154700

Orphanet: ORPHA558

[Disease characteristics](#)

Excerpted from the GeneReview: Marfan Syndrome
Marfan syndrome is a systemic disorder of connective tissue that affects the skeletal, and cardiovascular systems. FBN1 pathogenesis leads to Marfan syndrome to neonatal presentation of severe aortic dilation; displacement of the lens from the center of the eye; and Marfan syndrome are at increased risk for retinal detachment. Marfan syndrome is characterized by bone overgrowth and joint laxity. Features of Marfan syndrome of the ribs can push the sternum in (pectus excavatum) and are a major sources of morbidity and early mortality in Marfan syndrome. Dilatation of the aorta at the level of the sinuses of the aorta, aortic regurgitation, tricuspid valve prolapse, and enlargement of the aorta with Marfan syndrome approximates that of the general population.

Full text of GeneReview (by section):
[Summary](#) | [Diagnosis](#) | [Clinical Characteristics](#) | [Counseling](#) | [Resources](#) | [Molecular Genetics](#)

Authors:
Harry C Dietz [view full author information](#)

[Additional descriptions](#)

From OMIM
A heritable disorder of fibrous connective tissue, Marfan syndrome shows striking pleiotropism and clinical variability. The cardinal features occur in 3 systems--skeletal, ocular, and cardiovascular (McKusick, 1972; Pyeritz and McKusick, 1979; Pyeritz, 1993). It shares overlapping features with

Genetic Testing Registry

- [Deletion/duplication analysis \(56\)](#)
- [Detection of homozygosity \(1\)](#)
- [Detection of homozygosity \(1\)](#)
- [Mutation scanning of the entire coding region \(6\)](#)
- [Sequence analysis of select exons \(11\)](#)
- [Sequence analysis of the entire coding region \(97\)](#)
- [Targeted variant analysis \(7\)](#)
- [See all \(127\)](#)

Table of contents

- [Disease characteristics](#)
- [Additional descriptions](#)
- [Clinical features](#)
- [Term Hierarchy](#)
- [Professional guidelines](#)
- [Suggested Reading](#)
- [Recent clinical studies](#)
- [Recent systematic reviews](#)

Genetic Testing Registry

- [Deletion/duplication analysis \(56\)](#)
- [Detection of homozygosity \(1\)](#)
- [Detection of homozygosity \(1\)](#)
- [Mutation scanning of the entire coding region \(6\)](#)
- [Sequence analysis of select exons \(11\)](#)
- [Sequence analysis of the entire coding region \(97\)](#)
- [Targeted variant analysis \(7\)](#)
- [See all \(127\)](#)

Clinical resources

- [OMIM](#)
- [Orphanet](#)
- [ClinicalTrials.gov](#)

Go to:

Searching GTR – home page

GTR: GENETIC TESTING REGISTRY

All GTR Tests Conditions/Phenotypes Genes Labs GeneReviews

Advanced search for tests

Search All GTR

Search all 35032 tests, 10487 conditions, 4189 genes, and 476 labs

YouTube GTR Tutorials

IMPORTANT NOTE: NIH does not independently verify information submitted to the GTR; it relies on submitters to provide information that is accurate and not misleading. NIH makes no endorsements of tests or laboratories listed in the GTR. GTR is not a substitute for medical advice. **Patients and consumers** with specific questions about a genetic test should contact a health care provider or a genetics professional.

- Autocomplete dictionary -> Item specific page
- Search button -> List of records that match your query

GTR homepage below the search box

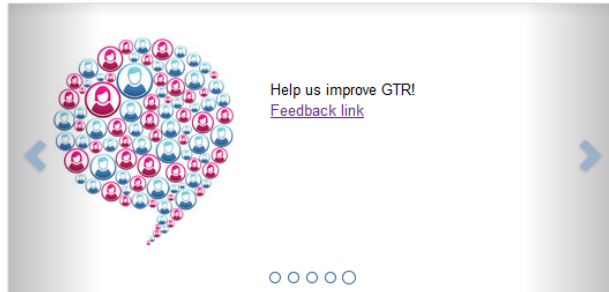

Find GTR Content

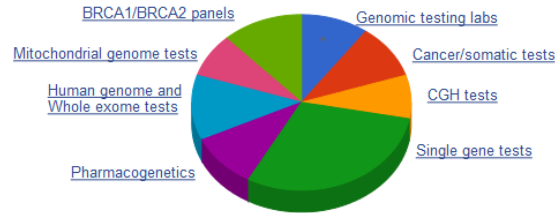

[All GTR data](#)

About GTR®

The Genetic Testing Registry (GTR®) provides a central location for voluntary submission of genetic test information by providers. The scope includes the test's purpose, methodology, validity, evidence of the test's usefulness, and laboratory contacts and credentials. The overarching goal of the GTR is to advance the public health and research into the genetic basis of health and disease

- [How to use GTR](#)
- [Frequently asked questions](#)
- [GTR News](#)
- [GTR Information at NIH Office of the Director](#)
- [GTR in the community](#)
- [Contact us and provide feedback](#)

GTR Data

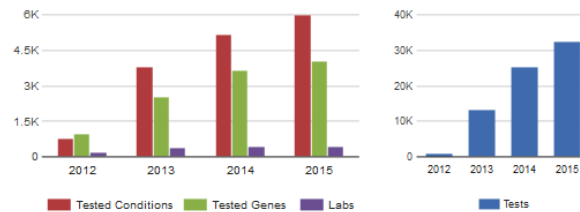

[FTP: Download GTR data and documents](#)

Worldwide Lab Participation in GTR

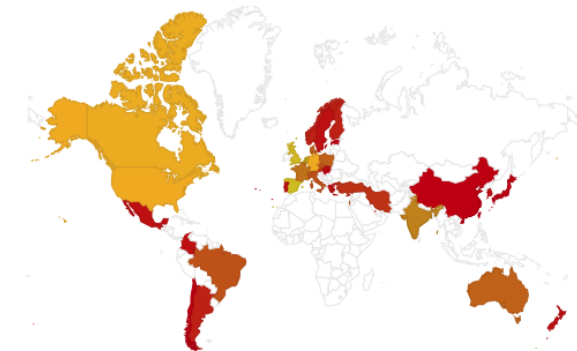

[GTR labs by country](#)

Resources Included in GTR

GTR includes information from resources such as ClinVar and MedGen from within the NIH and many resources from outside the NIH.

[See a list of all related resources](#)

Submitting Information to GTR

[Access the Submission User Interface](#)

- [How to submit data](#)
- [Code of Conduct](#)
- [Submission templates](#)

Locate a Genetics Professional

[ACMG Genetics Clinics Database](#)

American College of Medical Genetics and Genomics database, with map-based views.

[NSGC Directory](#)

National Society of Genetic Counselors directory.

[NCI Cancer Genetics Services Directory](#)

National Cancer Institute directory of professionals who provide cancer genetics services.

[ABMGG Directory](#)

American Board of Medical Genetics and Genomics directory of board-certified geneticists.

[ABGC Directory](#)

American Board of Genetic Counseling directory of board-certified genetic counselors.

Competency: Interpersonal & Communication Skills

- Communicating genetic information to patients
- Role of genetic professionals in care plan
- Informed decision-making, non-directive counseling
- Offer psych and social support to families

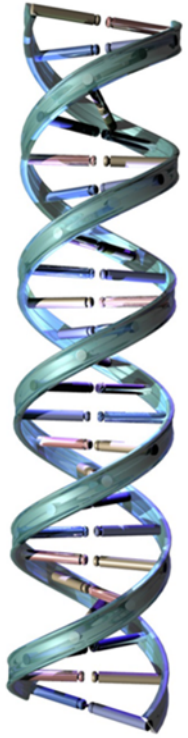

Support Groups

- [The Arc](#) provides information to help children and families with Autism, Down syndrome, Fetal Alcohol Syndrome, and many other intellectual/developmental disabilities.
- [Brave Kids](#) has an online resource for children with special needs and their families. There are message boards, resources, and games.
- [The Compassionate Friends](#) offers help to families in dealing with grief following the death of a child of any age.
- [Family Voices](#) an organization promoting quality health care for all children and youth, particularly those with special health care needs.
- [The Father's Network](#) provides information and resources to help families raising children with special health care needs and developmental disabilities.
- [March of Dimes](#) works to assure that babies are born healthy. Through research, outreach, education, and advocacy, MOD addresses issues such as prematurity, low birth weight, and birth defects.

Competency: Practice-based learning & improvement

Use information technology to obtain current and credible information about genetics for self, patients, and colleagues.

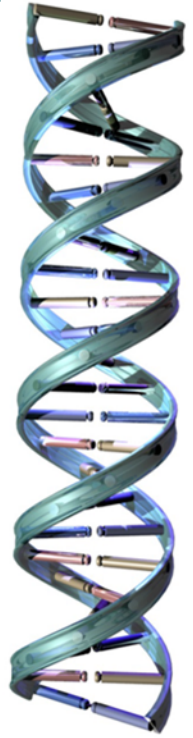

Clinical Pharmacogenetics Implementation Consortium (CPIC)

- Purpose of CPIC is to “translate genetic information into clinical actions and to make recommendations for actionable pharmacogenetic variants”
- Group of clinical pharmacologists, clinicians and scientists that review all current literature and develop recommendations and algorithms to guide drug dosing based on pharmacogenotypes

Example of CPIC recommendation

Clopidogrel

- Pro-drug, requires CYP2C19 metabolism to become active
- CYP2C19 SNPs have been identified leading to different metabolism phenotypes
 - CYP2C19* 1 (wild-type), normal functioning enzyme
 - CYP2C19*17, ultra-rapid metabolizer
 - **CYP19*2, CYP19*3, CYP2C19*4** have little or no functioning enzyme
 - 24% Caucasian, 33% African-Americans, 50% of Asians have at least one loss-of-function allele
 - In 227 cardiac patients, Shuldiner et al. found that 21% of clopidogrel subjects with CYP2C19 LOF SNPs reached study endpoint (death, non-fatal MI, urgent revascularization) compared with 10% without the LOF SNPs

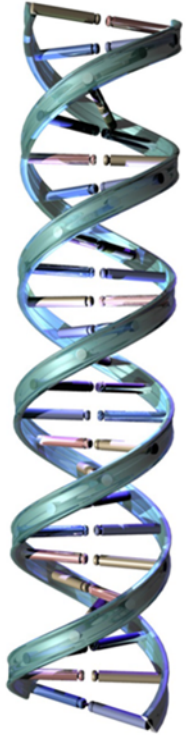
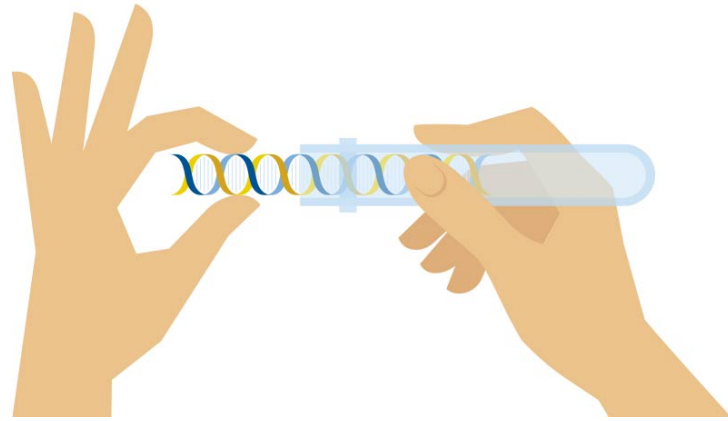

Competency: Professionalism

- Examine on a regular basis one's competence in genetics/genomics as pertinent to one's practice setting.
- Discuss financial, ethical, legal, and social issues related to genetic testing and recording of genetic information.

Psychosocial & Ethical Implications

- Complexity of information
 - Medical literacy vs. statistical literacy
- Promise vs. reality
- Informed health decisions vs. burden of knowledge
- Privacy/Confidentiality
- Equal access to health care
- Grey areas of clinical utility vs. personal utility
- Effects on families
 - Guilt, blame, fear, anxiety, depression
 - Gatekeepers, Communicators, Decision Makers
 - Neurogenethics Carli, T. (2015). Applied & Translational Research 5:18-22.

Incidental Findings-What to Do

- A finding concerning an individual research participant that has potential health or reproductive importance and is discovered in the course of conducting research but is beyond the aims of the study.”
 - Wolf, S., et al. (2012). Managing incidental findings and research results in genomic research involving biobanks and archived datasets. *Genetics in Medicine*, 4, 361-384.



ACMG 2013 Policy Statement

- Specific to clinical application of whole genome analysis
- Laboratories should interrogate the genome for a list of 59 specific genes associated with specific phenotype/syndromes.
- **Duty to warn surpasses patient autonomy**
- Decision to disclose these results should not be restricted to the age of majority but encompass disclosure of results including adult onset disorders to the parents of children.
- Option to opt out
 - Green, R. et al.(2013). ACMG recommendations for reporting of incidental findings in clinical exome and genome sequencing. *Genetics in Medicine*, 15(7), 565-574.



Genetic Information Nondiscrimination Act (GINA) of 2008

- GINA protects Americans from discrimination based on their genetic information in both health insurance (Title I) and employment (Title II).
- GINA does NOT apply to life insurance or long-term care insurance companies that may withhold services based on genetic tests.



Competency: Interprofessional Collaboration

-Seek coordination and collaboration with an interprofessional team of health care professionals

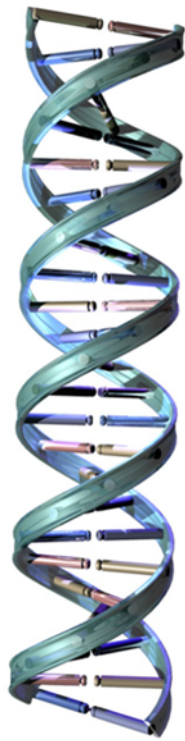

How to Find the Experts

- **National Society of Genetic Counselors (NSGC)**, www.nsgc.org (*Click on “Find a Genetic Counselor” on the top navigation bar*)
- **GeneClinics**, www.geneclinics.org (*Click on “Clinic Directory” in center of screen*)
- **American Society of Human Genetics (ASHG)**, www.ashg.org (*Click on “Find a Member” in top right of screen*)
- **American College of Medical Genetics (ACMG)**, www.acmg.net (*Click on “Find Genetics Services” in the top right of screen*)



Competency: Systems-based practice

-Identify key aspects of health care systems as they apply to clinical genetics.

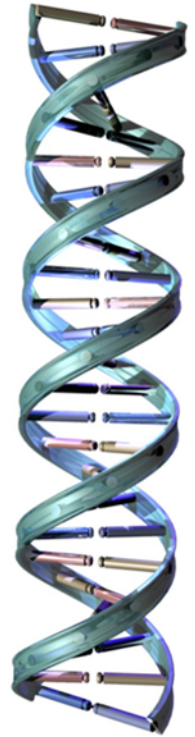

How much will this cost?



Deflation in Medicine?

Sequencing whole human genome

- 2003 → ~\$2.7 billion
 - 2006 → \$300,000
 - 2014 → \$20,000
 - 2016 → \$1000
 - 2019 → \$600*
- 2020 → \$250 (whole exome)*
- 2020 → <\$1000



Competency: Systems-based practice

- Identify key aspects of health care systems as they apply to clinical genetics.
 - What tests are available at your institution?
 - What do these tests cost?
 - What tests are covered by insurances?
 - What populations would benefit from genetic screening and what kind of education would they need?
 - What is the impact of health disparities and/or access for patients?
 - What kind of availability for these tests are there?



Fast and Furious Resources



Types of genetic information relevant to patient care

- Conditions
 - MedGen <https://www.ncbi.nlm.nih.gov/medgen/>
- Genetic tests
 - GTR <https://www.ncbi.nlm.nih.gov/gtr/>
- Variations and their relationship to human health
 - ClinVar <https://www.ncbi.nlm.nih.gov/clinvar/>



PGx Resources

- PharmGKB
 - Pharmacogenomics Knowledge Base
 - Collects, curates and disseminates knowledge about the impact of human genetic variation on drug responses
- CPIC
 - Clinical Pharmacogenetics Implementation Consortium
 - Peer-reviewed guidelines
 - Designed to help clinicians understand **HOW** available genetic test results should be used to optimize drug therapy
 - Freely accessible online
 - Endorsed by ASHP, ASCPT and other external networks 



Welcome to SPAGG

The Society of Physician Assistants in Genetics and Genomics (SPAGG) is a professional organization comprised of PAs in the specialty of Genetics. Founded in 2018, SPAGG is recognized as a Special Interest Group affiliated with the American Academy of Physician Assistants (AAPA). SPAGG is dedicated to the education, advocacy, and placement of PAs in the field of Genetics in order to increase patient access to quality care while helping alleviate the nationwide shortage of board certified medical geneticists.



Forum Updates

- ▶ [New Job Posted](#)
Thursday, October 04, 2018 11:07 AM • Anonymous

Articles

- ▶ [Expert Research and Branding Firm Selected to Conduct PA Title Change Investigation](#)

Upcoming Events

- [ACMG ANNUAL CLINICAL GENETICS MEETING](#)
Tuesday, April 02, 2019 • Seattle, WA



PA's in Genetics and Genomics

- The purpose of a PA in genetics is to increase patient access to quality care while helping alleviate the nationwide shortage of medical geneticists.
- His role at the GGC
 - 2 clinic days in Greenwood
 - 1 clinic day in Columbia
- Getting up to speed
 - Weekly Monday patient review
 - Graduate course
 - Laboratory rotations
 - Attending ACMG and SERGG

Fun Reading

Francis Collins

- The Language of Life
- The Language of God

Bryan Sykes

- The Seven Daughters of Eve
- Adam's Curse

James Watson

- Double Helix

Brenda Maddox

- Rosalind Franklin: The Dark Lady of DNA

Rebecca Skloot

- The Immortal Life of Henrietta Lacks



Thank you!!!
Nguyen Park, MS, PA-C, DFAAPA
pagenesig@gmail.com

